



VRV 5 S-series  
Air Conditioning  
Technical Data  
RXYSA-AV1





# Table of contents

# RXYS-A-1

---

1	<b>Features</b>	4
	RXYS-A-1	4
2	<b>Specifications</b>	5
3	<b>Options</b>	8
	Options	8
4	<b>Combination table</b>	9
	Combination Table	9
5	<b>Capacity tables</b>	10
	Capacity Table Legend	10
	Capacity Correction Factor	11
6	<b>Dimensional drawings</b>	13
	Dimensional Drawings	13
7	<b>Centre of gravity</b>	14
	Centre of Gravity	14
8	<b>Piping diagrams</b>	15
	Piping Diagrams	15
9	<b>Wiring diagrams</b>	16
	Notes & Legends	16
	Wiring Diagrams - Single Phase	17
10	<b>External connection diagrams</b>	18
	External Connection Diagrams	18
11	<b>Sound data</b>	19
	Sound Power Spectrum	19
	Sound Pressure Spectrum - Cooling	22
	Sound Pressure Spectrum - Heating	24
	Sound power spectrum at high ESP	26
	Sound level data Quiet mode	27
12	<b>Installation</b>	28
	Installation Method	28
	Refrigerant Pipe Selection	31
13	<b>Operation range</b>	32
	Operation Range	32
14	<b>Appropriate Indoors</b>	33
	Appropriate Indoors	33

# 1 Features

## 1 - 1 RXYSA-AV1

- › Reduced CO2 equivalent thanks to the use of lower GWP R-32 refrigerant and lower refrigerant charge
- › Top sustainability over the entire lifecycle, thanks to market leading real-life seasonal efficiency
- › Compact (870mm high) and lightweight single fan design makes the unit unobtrusive, saves space and is easy to install
- › Easy to transport thanks to lightweight and compact design
- › Market-leading serviceability and handling, thanks to wide access area, 7-segment display and additional handle
- › Offering like-for-like R-410A installation flexibility
- › Specially designed indoor units for R-32, ensuring low sound and maximum efficiency

1



Inverter

## 2 Specifications

### 1 - 1 RXYSA-AV1

Technical Specifications				RXYSA4AV1	RXYSA5AV1	RXYSA6AV1	
Recommended combination				3 x FXSA25A2VEB + 1 x FXSA32A2VEB	4 x FXSA32A2VEB	2 x FXSA32A2VEB + 2 x FXSA40A2VEB	
Cooling capacity	Prated,c		kW	12.1 (1)	14.0 (1)	15.5 (1)	
	Nom.	6°CWB	kW	12.1 (2)	14.0 (2)	15.5 (2)	
	Prated,h		kW	8.4	9.7	10.7	
Heating capacity	Max.	6°CWB	kW	14.2 (2)	16.0 (2)	18.0 (2)	
	Heating	Nom.	6°CWB	kW	2.69 (2)	3.33 (2)	3.78 (2)
Power input - 50Hz	Heating	Nom.	6°CWB	kW	2.69 (2)	3.33 (2)	3.78 (2)
COP at nom. capacity	6°CWB		kW/kW	4.49	4.20	4.10	
SCOP				5.1	4.7		
SEER				8.2	7.7	7.6	
ηs,c			%	324.5	306.1	301.0	
ηs,h			%	200.5	185.7	183.6	
Space cooling	A Condition (35°C -27/19)	EERd		3.4	3.1	3.0	
		Pdc	kW	12.1	14.0	15.5	
	B Condition (30°C -27/19)	EERd		5.8	5.3	5.0	
		Pdc	kW	8.9	10.3	11.4	
	C Condition (25°C -27/19)	EERd		10.9	9.8		
		Pdc	kW	5.7	6.6	7.3	
	D Condition (20°C -27/19)	EERd		18.5	19.4	19.0	
		Pdc	kW	4.9	4.5	4.9	
Space heating (Average climate)	TBivalent	COPd (declared COP)		2.8	2.6	2.5	
		Pdh (declared heating cap)	kW	8.4	9.7	10.7	
		Tbiv (bivalent temperature)	°C		-10		
	TOL	COPd (declared COP)		2.8	2.6	2.5	
		Pdh (declared heating cap)	kW	8.4	9.7	10.7	
		Tol (temperature operating limit)	°C		-10		
	A Condition (-7°C)	COPd (declared COP)		3.4	2.9		
		Pdh (declared heating cap)	kW	7.4	8.5	9.5	
		B Condition (2°C)	COPd (declared COP)		4.9	4.5	4.3
	Pdh (declared heating cap)		kW	4.5	5.2	5.8	
	C Condition (7°C)	COPd (declared COP)		7.0	6.7	7.0	
		Pdh (declared heating cap)	kW		3.3	3.7	
	D Condition (12°C)	COPd (declared COP)			8.9	9.0	
		Pdh (declared heating cap)	kW		3.9		
	Capacity range			HP	4	5	6
	PED	Category			Category III		
Most critical part		Name Ps*V	Bar*l	Accumulator 257			
Maximum number of connectable indoor units				13 (3)	16 (3)	18 (3)	
Indoor index connection	Min.			50.0	62.5	70.0	
	Nom.			100	125	140	
	Max.			130.0	162.5	182.0	
Dimensions	Unit	Height	mm	869			
		Width	mm	1,100			
		Depth	mm	460			
	Packed unit	Height	mm	1,050			
Dimensions	Packed unit	Width	mm	1,205			
		Depth	mm	569			
Weight	Unit		kg	102			
	Packed unit		kg	115			
Packing	Material			Carton			
	Weight		kg	4			
Packing 2	Material			Wood			
	Weight		kg	6			
Packing 3	Material			Plastic			
	Weight		kg	1			
Casing	Colour			Ivory white			
	Material			Painted galvanized steel plate			
Heat exchanger	Type			Cross fin coil			
	Indoor side			Air			
	Outdoor side			Air			
	Air flow rate	Cooling	Rated	m <sup>3</sup> /h	5,342		
		Heating	Rated	m <sup>3</sup> /h	5,519	6,204	

## 2 Specifications

### 1 - 1 RXYSA-AV1

2

Technical Specifications					RXYSA4AV1	RXYSA5AV1	RXYSA6AV1
Fan	Quantity				1		
	External static pressure	Max.	Pa	45			
Fan motor	Quantity				1		
	Type				DC motor		
	Output		W		234		
Compressor	Quantity				1		
	Type				Hermetically sealed swing compressor		
Operation range	Crankcase heater		W		33		
	Cooling	Min.	°CDB	-5			
		Max.	°CDB	46			
	Heating	Min.	°CWB	-20			
Max.		°CWB	16				
Sound power level	Cooling	Nom.	dBa	67.0 (4)	68.1 (4)	69.0 (4)	
	Heating	According to ENER LOT21		57.0 (5)	59.0 (5)	60.0 (5)	
Sound pressure level	Cooling	Nom.	dBa	49.0 (6)	51.0 (6)		
	Heating			50.0 (6)	52.0 (6)		
Refrigerant	Type				R-32		
	GWP				675.0		
	Charge		TCO2Eq		2.30		
	Charge		kg		3.40		
Refrigerant oil	Type				FW68DE		
	Charged volume		l		1.9		
Piping connections	Liquid	Type			Braze connection		
		OD	mm		9,52		
	Gas	Type			Braze connection		
		OD	mm		15,9		
	Total piping length	System	Actual	m	300 (7)		
	Level difference	OU - IU	Outdoor unit in highest position	m	50		
		Indoor unit in highest position	m	40			
Defrost method					Reversed cycle		
Capacity control					Inverter controlled		
Indication if the heater is equipped with a supplementary heater					no		
Supplementary heater	Back-up capacity	Heating	elbu	kW	0.000		
		Cooling	PCK	kW	0.000		
Power consumption in other than active mode	heater	Heating	PCK	kW	0.031		
		Off mode	Cooling	POFF	kW	0.040	
		Heating	POFF	kW	0.015		
	Standby mode	Cooling	PSB	kW	0.040		
		Heating	PSB	kW	0.015		
	Thermostat-off mode	Cooling	PTO	kW	0.004		
Heating		PTO	kW	0.049			
Cooling	Cdc (Degradation cooling)				0.25		
Heating	Cdh (Degradation heating)				0.25		
Safety devices	Item	03			Inverter overload protector		
		04			Compressor motor thermal protector		
		05			Fan driver overload protector		
		06			PC board fuse		
		07			High pressure switch (automatic)		
		08			High pressure switch (manual)		

Standard accessories: Installation and operation manual; Quantity: 1;

Standard accessories: General safety precautions; Quantity: 1;

Standard accessories: Peel off F-gas label; Quantity: 1;

Standard accessories: Refrigerant label for F-gas regulation; Quantity: 1;

Standard accessories: Tie-wraps; Quantity: 2;

Standard accessories: Auxiliary piping set; Quantity: 1;

Standard accessories: Caution label; Quantity: 1;

## 2 Specifications

### 1 - 1 RXYSA-AV1

Electrical Specifications			RXYSA4AV1	RXYSA5AV1	RXYSA6AV1
Power supply	Name		V1		
	Phase		1~		
	Frequency	Hz	50		
	Voltage	V	220-240		
Power supply intake	Both indoor and outdoor unit				
Voltage range	Min.	%	-10		
	Max.	%	10		
Current	Nominal running current (RLA)	Cooling A	16.2 (8)	20.3 (8)	22.8 (8)
	Starting current (MSC) - remark	Zmax List	See note 9		
Current - 50Hz			No requirements		
	Minimum Ssc value	kVa	123 (10)	154 (10)	173 (10)
	Minimum circuit amps (MCA)	A	27.0 (11)		
	Maximum fuse amps (MFA)	A	32 (12)		
	Total overcurrent amps (TOCA)	A	27.0 (13)		
	Full load amps (FLA)	Total A	1.3 (14)		
Wiring connections - 50Hz supply	For power supply	Quantity	3G		
	For connection with indoor	Quantity	2		
		Remark	F1,F2		

(1)Cooling: indoor temp. 27°CDB, 19°CWB; outdoor temp. 35°CDB; equivalent piping length: 7.5m; level difference: 0m |

(2)Heating: indoor temp. 20°CDB; outdoor temp. 7°CDB, 6°CWB; equivalent refrigerant piping: 7.5m; level difference: 0m |

(3)The actual number of units depends on the connection ratio (CR) and the restrictions for the system. |

(4)Sound power level is an absolute value that a sound source generates. |

(5)According to ENER Lot 21 |

(6)Sound pressure level is a relative value, depending on the distance and acoustic environment. For more details, please refer to the sound level drawings. |

(7)Refer to refrigerant pipe selection or installation manual |

(8)RLA is based on following conditions: indoor temp. 27°CDB, 19°CWB; outdoor temp. 35°CDB |

(9)MSC means the maximum current during start up of the compressor. This unit uses only inverter compressors. Starting current is always ≤ max. running current. |

(10)In accordance with EN/IEC 61000-3-12, it may be necessary to consult the distribution network operator to ensure that the equipment is connected only to a supply with Ssc ≥ minimum Ssc value |

(11)MCA must be used to select the correct field wiring size. The MCA can be regarded as the maximum running current. |

(12)MFA is used to select the circuit breaker and the ground fault circuit interrupter (earth leakage circuit breaker). |

(13)TOCA means the total value of each OC set. |

(14)FLA means the nominal running current of the fan

# 3 Options

## 3 - 1 Options

**3**
**RXYSA-AV1**  
**RXYSA-AY1**
**VRV5-S Heat pump**  
 Option list

Nr.	Item	RXYSA4~6A7V1B	RXYSA4~6A7Y1B
1.	Refnet header	KHRQ22M29H	KHRQ22M29H
2.	Refnet joint	KHRQ22M20T	KHRQ22M20T
3a.	Cool/heat selector (switch)	KRC19-26	KRC19-26
3b.	Cool/heat selector (fixing box)	KJB111A	KJB111A
4.	VRV configurator	EKPCCAB4	EKPCCAB4
5.	Bottom plate heater	EKBPH250D	EKBPH250D

Notes

1. All options are kits
2. Cool/Heat selector PCB is standard in unit.
3. To mount option '3a', option '3b' is required.

**3D127872**



## 4 Combination table

### 4 - 1 Combination Table

**RXYSA-AV1**  
**RXYSA-AY1**

**VRV5-S** Heat pump

Indoor unit combination restrictions

Combination table	RXYSA4~6A7V1B	RXYSA4~6A7Y1B
·VRV* R32 DX· indoor unit	O	O
·RA DX· indoor unit	X	X
Hydrobox unit	X	X
Air handling unit (AHU)	X	X

O : Allowed

X : Not allowed

**3D127866**

## 5 Capacity tables

### 5 - 1 Capacity Table Legend

5

In order to fulfill more your requirements on quick access of data in the format you require, we have developed a tool to consult capacity tables.

Below you can find the link to the capacity table database and an overview of all the tools we have to help you select the correct product:

- **Capacity table database:** lets you find back and export quickly the capacity information you are looking for based upon unit model, refrigerant temperature and connection ratio.
- You can access the capacity table viewer here:  
[https://my.daikin.eu/content/denv/en\\_US/home/applications/software-finder/capacity-table-viewer.html](https://my.daikin.eu/content/denv/en_US/home/applications/software-finder/capacity-table-viewer.html)



- An overview of **all software tools** that we offer can be found here:  
[https://my.daikin.eu/denv/en\\_US/home/applications/software-finder.html](https://my.daikin.eu/denv/en_US/home/applications/software-finder.html)



# 5 Capacity tables

## 5 - 2 Capacity Correction Factor

**RXYS44V1**

**RXYS44Y1**

**RXYS44A7(V/Y)1B**

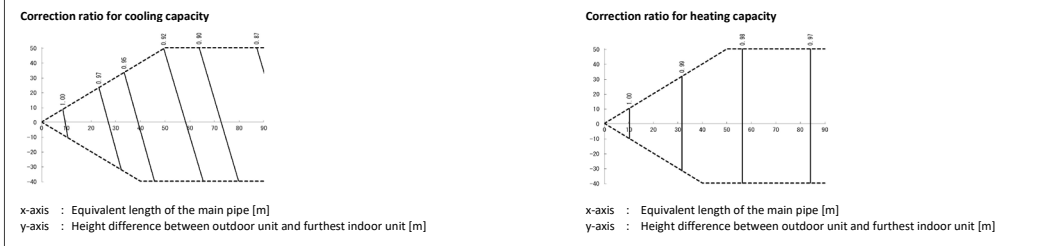

- Notes**
- These figures illustrate the capacity correction factor due to the piping length for a standard indoor unit system at maximum load (with the thermostat set to maximum), under standard conditions. Moreover, under partial load conditions, there is only a minor deviation for the capacity correction ratio, as shown in the above figures.
  - With this outdoor unit, the following control is used:- in case of cooling: constant evaporating pressure control- in case of heating: constant condensing pressure control
  - Method of calculating the capacity of the outdoor units.  
The maximum capacity of the system will be either the total capacity of the indoor units or the maximum capacity of the outdoor units as mentioned below, whichever is less.

**Indoor connection ratio ≤ 100%.**  
 Maximum capacity of outdoor units = Capacity of outdoor units from capacity table at 100% connection ratio. x Correction factor for main pipe -  $\frac{\text{Longest branch length}}{40 \text{ m}}$  x 0,02

**Indoor connection ratio > 100%.**  
 Maximum capacity of outdoor units = Capacity of outdoor units from capacity table at installed connection ratio. x Correction factor for main pipe -  $\frac{\text{Longest branch length}}{40 \text{ m}}$  x 0,02

- The correction factor for the main pipe can be found in graphs above.  
 The correction factor for the longest branch is calculated separately. The maximum allowed branch length of 40- m corresponds with correction factor 0,02.
- If the equivalent piping length between the outdoor unit and the furthest indoor unit is ≥ 90- m, the size of the main gas pipe (between outdoor unit and first refrigerant branch kit) must be increased. For the new diameters, see below.

Model	Standard liquid side Ø	Increased liquid side Ø	Standard gas side Ø	Increased gas side Ø
RXYS44A7V1B	9,5	Not increased	15,9	19,1
RXYS44A7Y1B				

- Equivalent length of the main pipe**
- Cooling mode = 80 m x 0,5 = 40 m
  - Heating mode = 80 m x 1,0 = 80 m
- Capacity correction ratio (height difference = 0)**
- Cooling mode = 0,95 - (30/40) x 0,02 = 0,935
  - Heating mode = 0,972 - (30/40) x 0,02 = 0,957

Equivalent length of the main pipe = Equivalent length of the main pipe x Correction factor

Choose the correction factor from the following table.

	Standard size	Size increase
Cooling	1,0	0,5
Heating	1,0	1,0

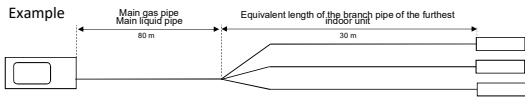

4D127880

**RXYS45V1**

**RXYS45Y1**

**RXYS45A7(V/Y)1B**

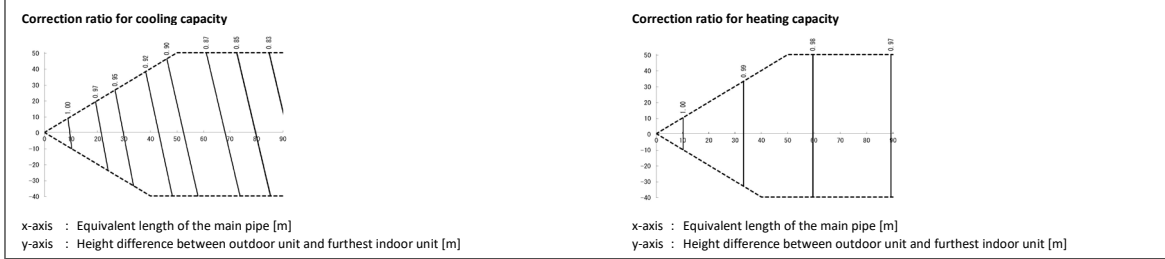

- Notes**
- These figures illustrate the capacity correction factor due to the piping length for a standard indoor unit system at maximum load (with the thermostat set to maximum), under standard conditions. Moreover, under partial load conditions, there is only a minor deviation for the capacity correction ratio, as shown in the above figures.
  - With this outdoor unit, the following control is used:- in case of cooling: constant evaporating pressure control- in case of heating: constant condensing pressure control
  - Method of calculating the capacity of the outdoor units.  
The maximum capacity of the system will be either the total capacity of the indoor units or the maximum capacity of the outdoor units as mentioned below, whichever is less.

**Indoor connection ratio ≤ 100%.**  
 Maximum capacity of outdoor units = Capacity of outdoor units from capacity table at 100% connection ratio. x Correction factor for main pipe -  $\frac{\text{Longest branch length}}{40 \text{ m}}$  x 0,02

**Indoor connection ratio > 100%.**  
 Maximum capacity of outdoor units = Capacity of outdoor units from capacity table at installed connection ratio. x Correction factor for main pipe -  $\frac{\text{Longest branch length}}{40 \text{ m}}$  x 0,02

- The correction factor for the main pipe can be found in graphs above.  
 The correction factor for the longest branch is calculated separately. The maximum allowed branch length of 40- m corresponds with correction factor 0,02.
- If the equivalent piping length between the outdoor unit and the furthest indoor unit is ≥ 90- m, the size of the main gas pipe (between outdoor unit and first refrigerant branch kit) must be increased. For the new diameters, see below.

Model	Standard liquid side Ø	Increased liquid side Ø	Standard gas side Ø	Increased gas side Ø
RXYS45A7V1B	9,5	Not increased	15,9	19,1
RXYS45A7Y1B				

- Equivalent length of the main pipe**
- Cooling mode = 80 m x 0,5 = 40 m
  - Heating mode = 80 m x 1,0 = 80 m
- Capacity correction ratio (height difference = 0)**
- Cooling mode = 0,928 - (30/40) x 0,02 = 0,913
  - Heating mode = 0,973 - (30/40) x 0,02 = 0,958

Equivalent length of the main pipe = Equivalent length of the main pipe x Correction factor

Choose the correction factor from the following table.

	Standard size	Size increase
Cooling	1,0	0,5
Heating	1,0	1,0

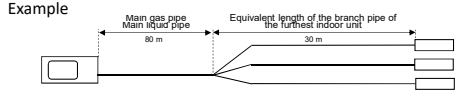

4D127880

# 5 Capacity tables

## 5 - 2 Capacity Correction main Factor

5

### RXYSA6AV1

### RXYSA6AY1

#### RXYSA6A7(V/Y)1B

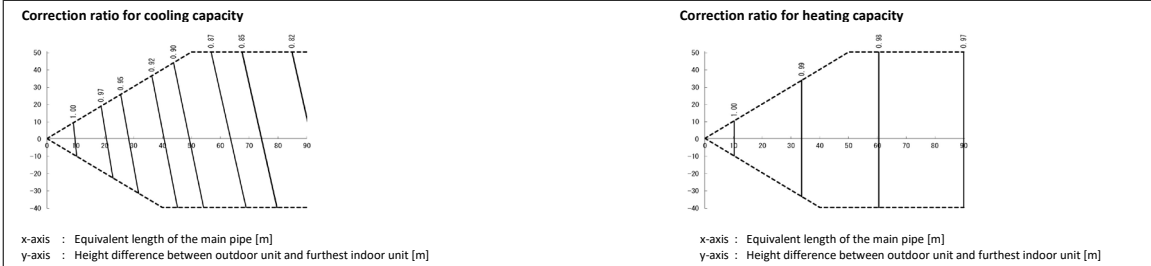

**Notes**

1. These figures illustrate the capacity correction factor due to the piping length for a standard indoor unit system at maximum load (with the thermostat set to maximum), under standard conditions. Moreover, under partial load conditions, there is only a minor deviation for the capacity correction ratio, as shown in the above figures.

2. With this outdoor unit, the following control is used: - in case of cooling: constant evaporating pressure control - in case of heating: constant condensing pressure control

**3. Method of calculating the capacity of the outdoor units.**

The maximum capacity of the system will be either the total capacity of the indoor units or the maximum capacity of the outdoor units as mentioned below, whichever is less.

**Indoor connection ratio ≤ 100%.**

$$\text{Maximum capacity of outdoor units} = \text{Capacity of outdoor units from capacity table at 100\% connection ratio.} \times \left[ \begin{array}{l} \text{Correction factor for main pipe} \\ \text{Longest branch length} \\ 40 \text{ m} \end{array} \right] \times 0,02$$

**Indoor connection ratio > 100%.**

$$\text{Maximum capacity of outdoor units} = \text{Capacity of outdoor units from capacity table at installed connection ratio.} \times \left[ \begin{array}{l} \text{Correction factor for main pipe} \\ \text{Longest branch length} \\ 40 \text{ m} \end{array} \right] \times 0,02$$

The correction factor for the main pipe can be found in graphs above.

The correction factor for the longest branch is calculated separately. The maximum allowed branch length of 40 m corresponds with correction factor 0,02.

4. If the equivalent piping length between the outdoor unit and the furthest indoor unit is ≥ 90 m, the size of the main gas pipe (between outdoor unit and first refrigerant branch kit) must be increased. For the new diameters, see below.

Model	Standard liquid side Ø	Increased liquid side Ø	Standard gas side Ø	Increased gas side Ø
RXYSA6A7V1B	9,5	Not increased	15,9	19,1
RXYSA6A7Y1B				

**Equivalent length of the main pipe**

- Cooling mode = 80 m x 0,5 = 40 m
- Heating mode = 80 m x 1,0 = 80 m

**Capacity correction ratio (height difference = 0)**

- Cooling mode = 0,92 - (30/40) x 0,02 = 0,905
- Heating mode = 0,973 - (30/40) x 0,02 = 0,958

**5. Equivalent length of the main pipe**

$$\text{Equivalent length of the main pipe} = \text{Equivalent length of the main pipe} \times \text{Correction factor}$$

Choose the correction factor from the following table.

	Standard size	Size increase
Cooling	1,0	0,5
Heating	1,0	1,0

**Example**

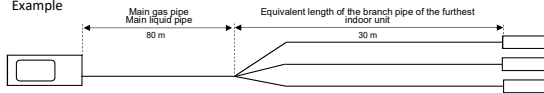

4D127880

### RXYSA-AV1

### RXYSA-AY1

## VRV5-S Heat pump

### Integrated heating capacity coefficient

The heating capacity tables do not take into account the capacity reduction in case of frost accumulation or defrost operation.

The capacity values that take these factors into account, or in other words, the integrated heating capacity values, can be calculated as follows:

**Formula**

- A = Integrated heating capacity
- B = Capacity characteristics value
- C = Integrated correction factor for frost accumulation (see table)

$$A = B * C$$

**Inlet air temperature of heat exchanger**

[°CDB/°CWB]	-7/-7.6	-5/-5.6	-3/-3.7	0/-0.7	3/2.2	5/4.1	7/6
RXYSA4A7V1B	0,79	0,74	0,73	0,72	0,73	0,74	1,00

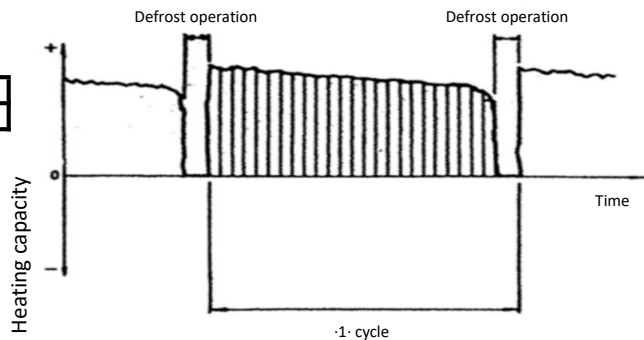

**Notes**

1. The figure shows the integrated heating capacity for a single cycle (from one defrost operation to the next).

2. When there is an accumulation of snow against the outdoor unit heat exchanger, there will always be a temporary reduction in capacity depending on the outdoor temperature (°C DB), relative humidity (RH) and the amount of frosting which occurs.

4D127879

# 6 Dimensional drawings

## 6 - 1 Dimensional Drawings

RXYSA-AV1  
RXYSA-AY1

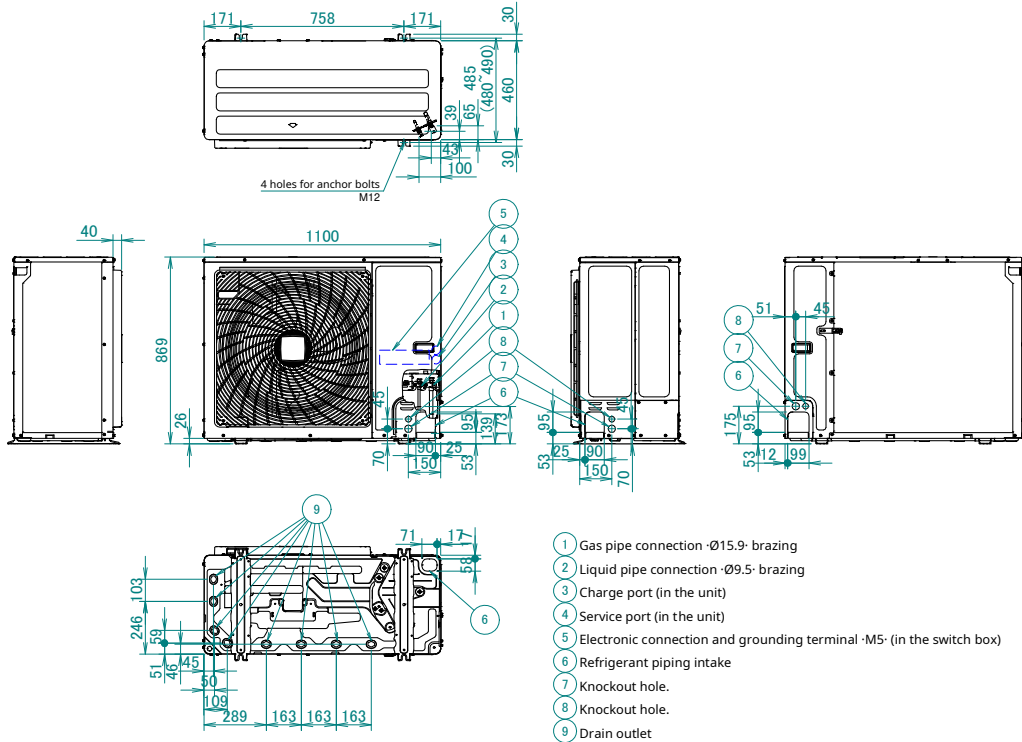

3D127871

# 7 Centre of gravity

## 7 - 1 Centre of Gravity

7

RXYSA-AV1  
RXYSA-AY1

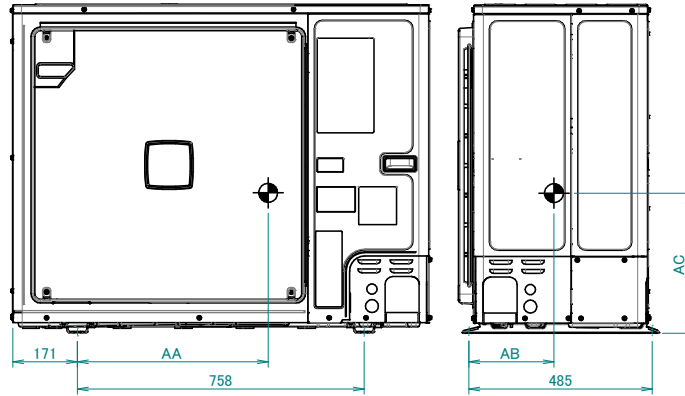

Model	AA	AB	AC
RZAG71N7V1B	520.3	238.7	357.8
RZAG71N7Y1B	525.9	224.7	359.8
RZAG100N7V1B	499.7	239.3	367.6
RZAG100N7Y1B	511.2	223.5	362.5
RZAG125/140N7V1B	486.3	229.2	371.8
RZAG125/140N7Y1B	493.4	215.8	372.2
RXYSA4/5/6A7V1B	530.4	249.9	389.0
RXYSA4/5/6A7Y1B			

4D120933B

# 8 Piping diagrams

## 8 - 1 Piping Diagrams

RXYSA-AV1  
RXYSA-AY1

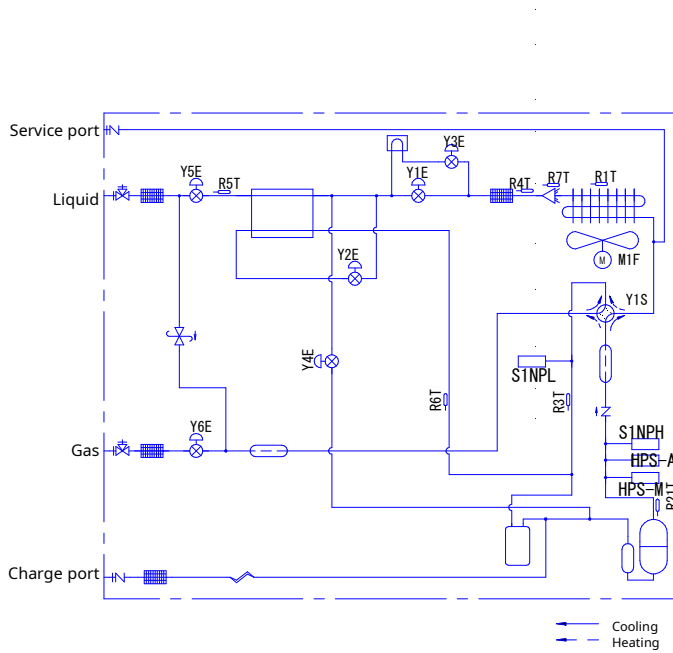

- Electronic expansion valve
- Charge port / Service port
- Stop valve
- Filter
- Check valve
- Pressure relief valve
- Heat sink (PCB)
- High pressure switch Automatic reset
- High pressure switch Manual reset
- High pressure sensor
- Low pressure sensor
- Double tube heat exchanger
- Distributor
- Propeller fan
- Heat exchanger
- Accumulator
- Compressor
- Compressor Accumulator
- Thermistor
- Capillary tube
- Muffler
- 4-way valve

— Cooling  
- - - Heating

3D127852

# 9 Wiring diagrams

## 9 - 1 Notes & Legend

### RXYS-AV1

#### NOTES to go through before starting the unit

1. Symbols

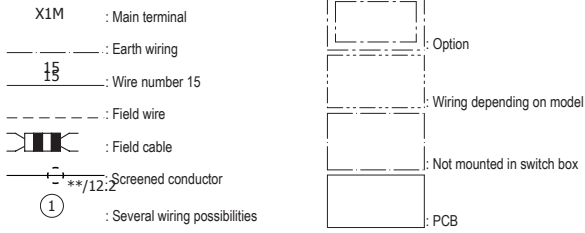

- Refer to the installation or service manual on how to use BS1 ~ BS3 push buttons and DS1-1 ~ DS1-2 DIP switches.
- Do not operate the unit by short-circuiting protection device S1PH. S1PH-A automatically resets after high pressure has been exceeded, S1PH-M has to be manually reset after high pressure has been exceeded.
- Refer to the installation manual for indoor-outdoor transmission F1-F2 wiring.
- When using the central control system, connect outdoor-outdoor transmission F1-F2.
- The capacity of the contact is 220-240V AC - 0.5A (Rush current needs 3A or less).
- Use dry contact for micro-current (1 mA or less 12V DC).
- Digital output: max 40V DC - 0.025A. Refer to installation manual for how to use this output.
- For X27A refer to the installation manual of the option.

#### POSITION IN SWITCH BOX

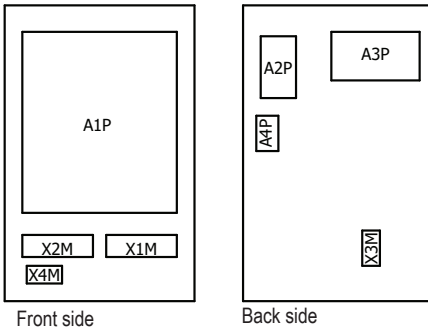

#### LEGEND

Part n°	Description
A1P	main PCB
A2P	sub PCB
A3P	back up PCB
A4P	cool / heat selector PCB
BS* (A1P)	push button switch
DS* (A1P)	dipswitch
E1H	* bottom plate heater
E1HC	crank case heater
F1U (A1P)	fuse T 31.5 A 250 V
F1U (A2P)	fuse T 3.15 A 250 V
F1U	fuse T 1.0 A 250 V
F2U (A1P)	fuse T 6.3 A 250 V
F3U (A1P)	fuse T 6.3 A 250 V
F6U (A1P)	fuse T 5 A 250 V
F101U (A3P)	fuse T 2.0 A 250 V
HAP (A1P,A3P)	running LED (service monitor-green)
K*T (A1P)	contactor on PCB
K*R (A*P)	relay on PCB
M1C	motor (compressor)
M1F	motor (fan)
PS* (A*P)	switching power supply
Q1	overload switch
Q1DI	# earth leakage circuit breaker
R1T	thermistor (ambient)
R3T	thermistor (suction)
R4T	thermistor (liquid)
R5T	thermistor (subcool)
R6T	thermistor (superheat)
R7T	thermistor (heat exchanger)
R10T	thermistor (fin)
R21T	thermistor (discharge)
R*T (A*P)	PTC thermistor
S1NPH	high pressure sensor
S1NPL	low pressure sensor
S1PH*	high pressure switch
S1S	* air control switch

Part n°	Description
S2S	* cool / heat switch
SEG* (A1P)	7-segment display
SFB	# mechanical ventilation error input
V1R, V2R (A1P)	IGBT power module
V3R (A1P)	diode module
X*A	PCB connector
X*M	terminal strip
X*Y	connector
Y1E	electronic exp. valve (main - EVM1)
Y2E	electronic exp. valve (EVT)
Y3E	electronic exp. valve (main - EVM2)
Y4E	electronic exp. valve (EVL)
Y5E	electronic exp. valve (EVSL)
Y6E	electronic exp. valve (EVSG)
Y1S	solenoid valve (4-way valve)
Y3S	# error operation output (SVEO)
Y4S	# leak sensor output (SVS)
Z*C	noise filter (ferrite core)
Z*F (A*P)	noise filter

\* : optional # : field supply

4D127736



# 9 Wiring diagrams

## 9-2 Wiring Diagrams - Single Phase

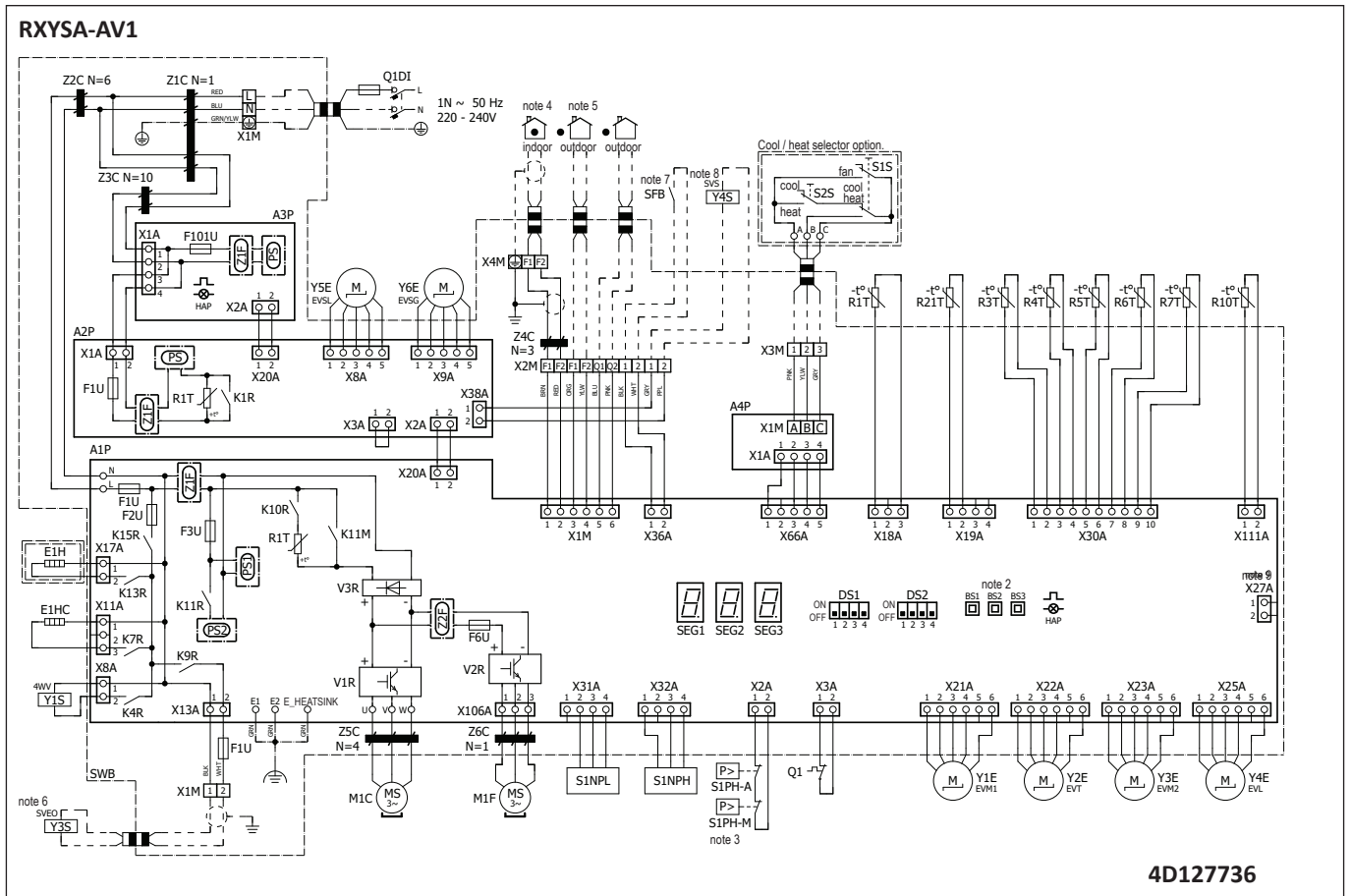

# 10 External connection diagrams

## 10 - 1 External Connection Diagrams

10

RXYSA-AV1

### External connection diagram

·VRV· indoor unit

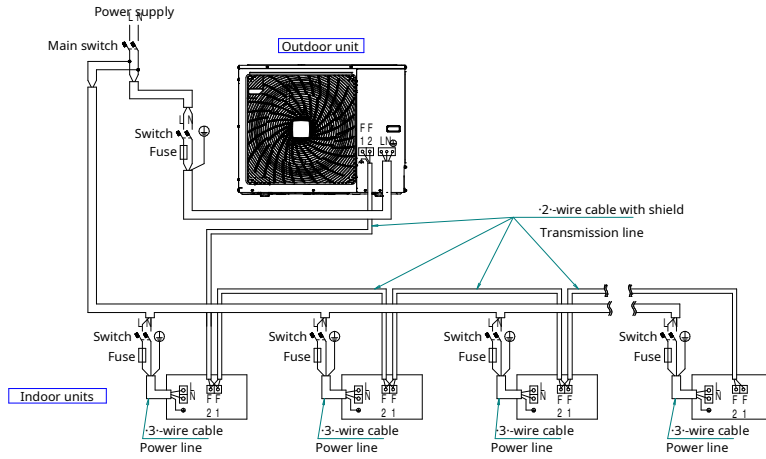

Notes

1. All wiring, components and materials to be procured on-site must comply with the applicable legislation.
2. Use copper conductors only
3. For more details, refer to the wiring diagram of the unit.
4. Install a circuit breaker for safety.
5. All field wiring and components must be provided by an authorised electrician.
6. Unit has to be grounded in compliance with the applicable legislation.
7. The wiring shown is a general points-of-connection guide and is not intended to include all details for a specific installation.
8. Make sure to install the switch and the fuse to the power line of each equipment.
9. Install a main to switch to (if necessary) immediately interrupt all the system's power sources.
10. Install an earth leakage circuit breaker.
11. To ensure proper earthing, connect the shields of the incoming and outgoing transmission wiring of each indoor unit to each other.
12. The unit is equipped with a refrigerant leak detection system for safety.  
To be effective, the unit MUST be electrically powered at all times after installation, except for maintenance.

2D127869

# 11 Sound data

## 11 - 1 Sound Power Spectrum

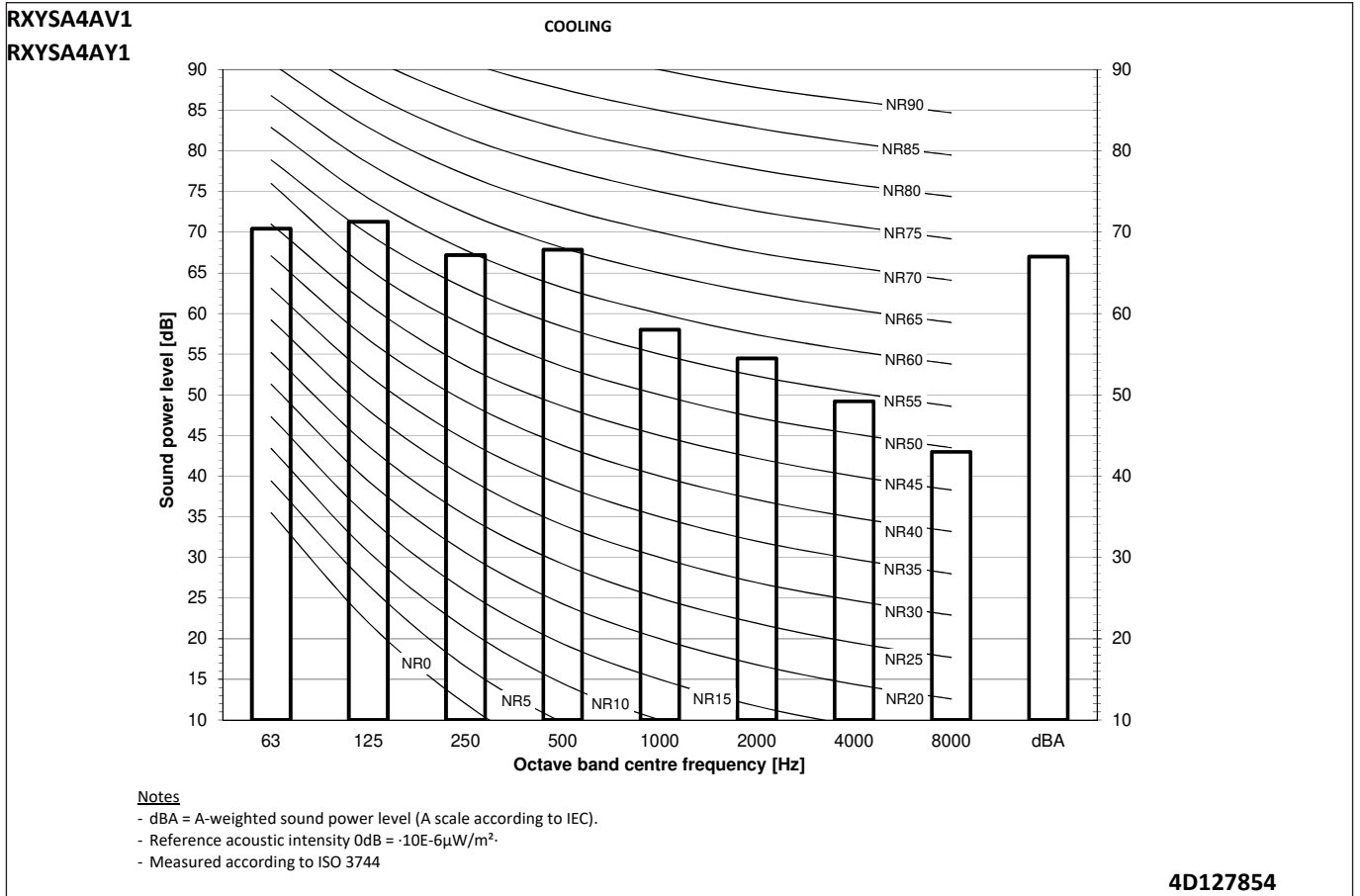

11

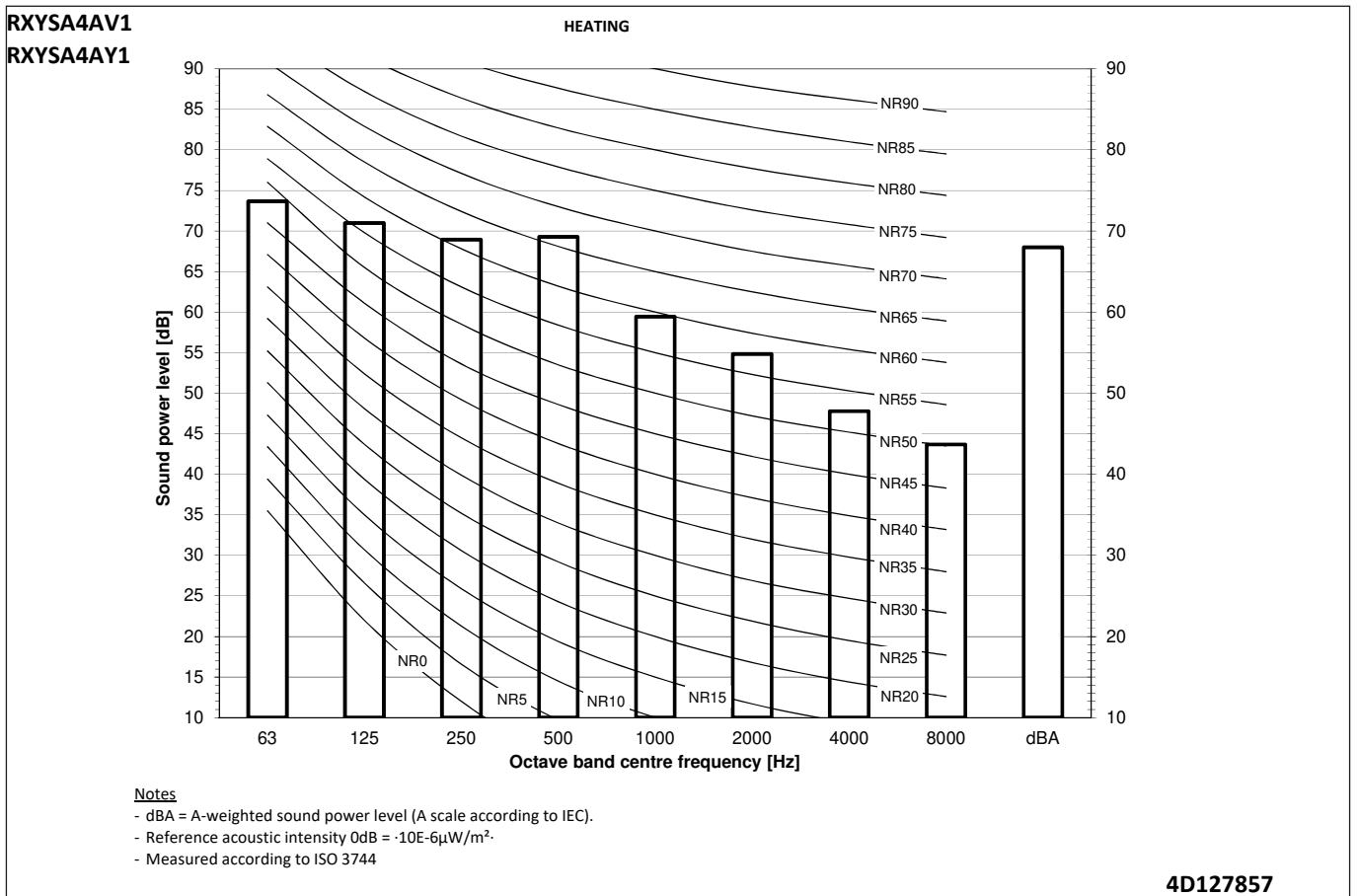

# 11 Sound data

## 11 - 1 Sound Power Spectrum

11

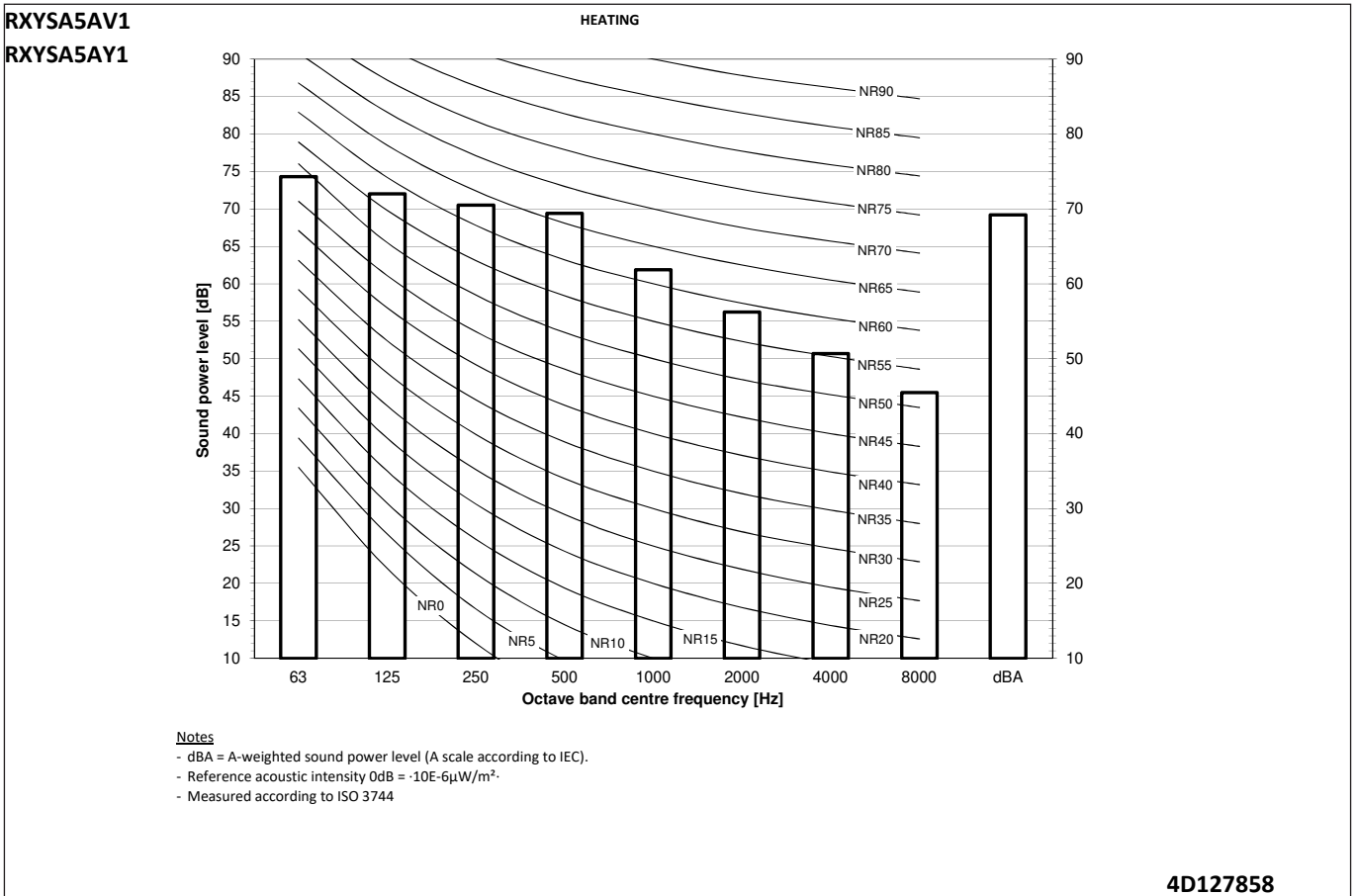
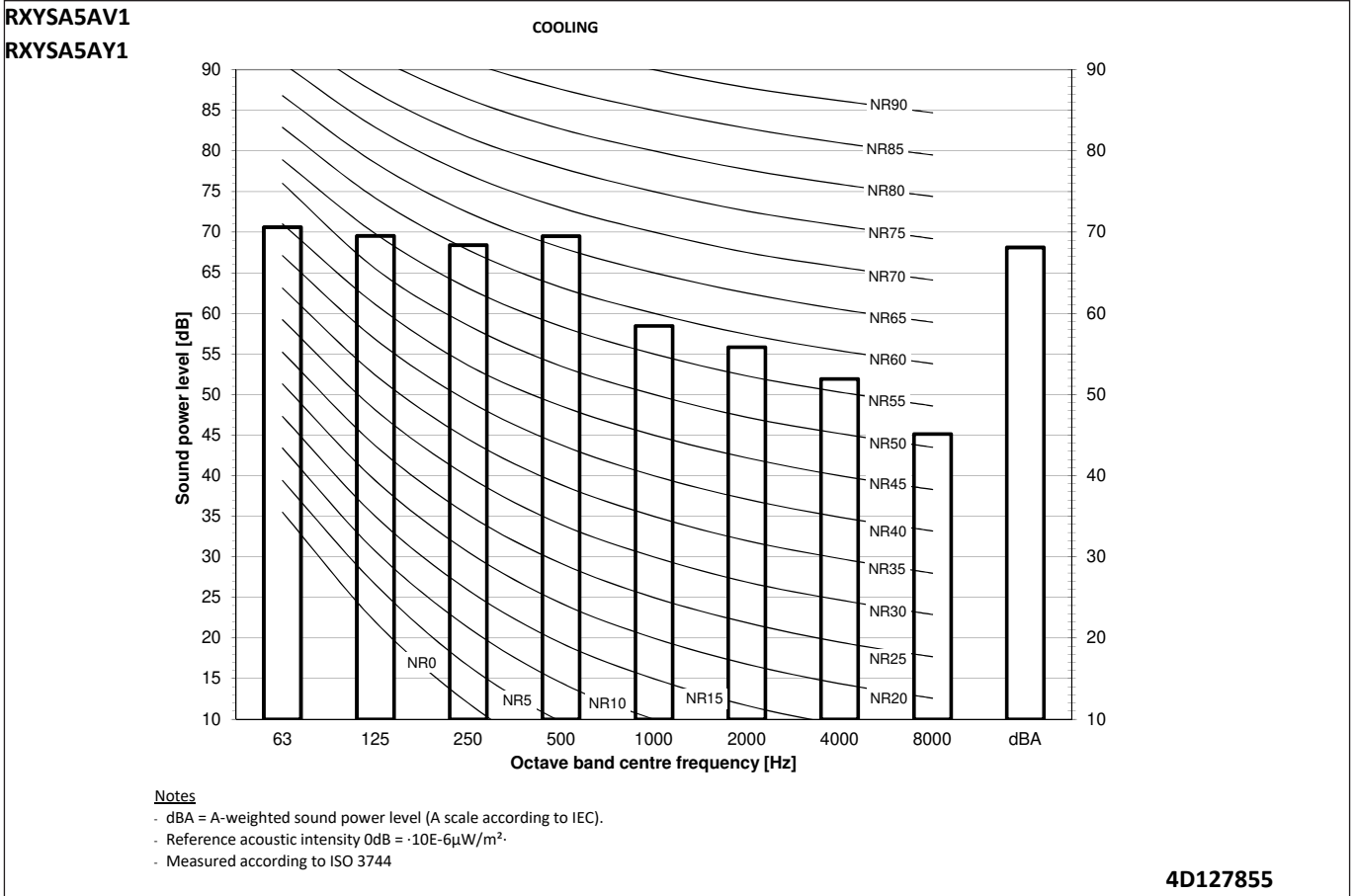

# 11 Sound data

## 11 - 1 Sound Power Spectrum

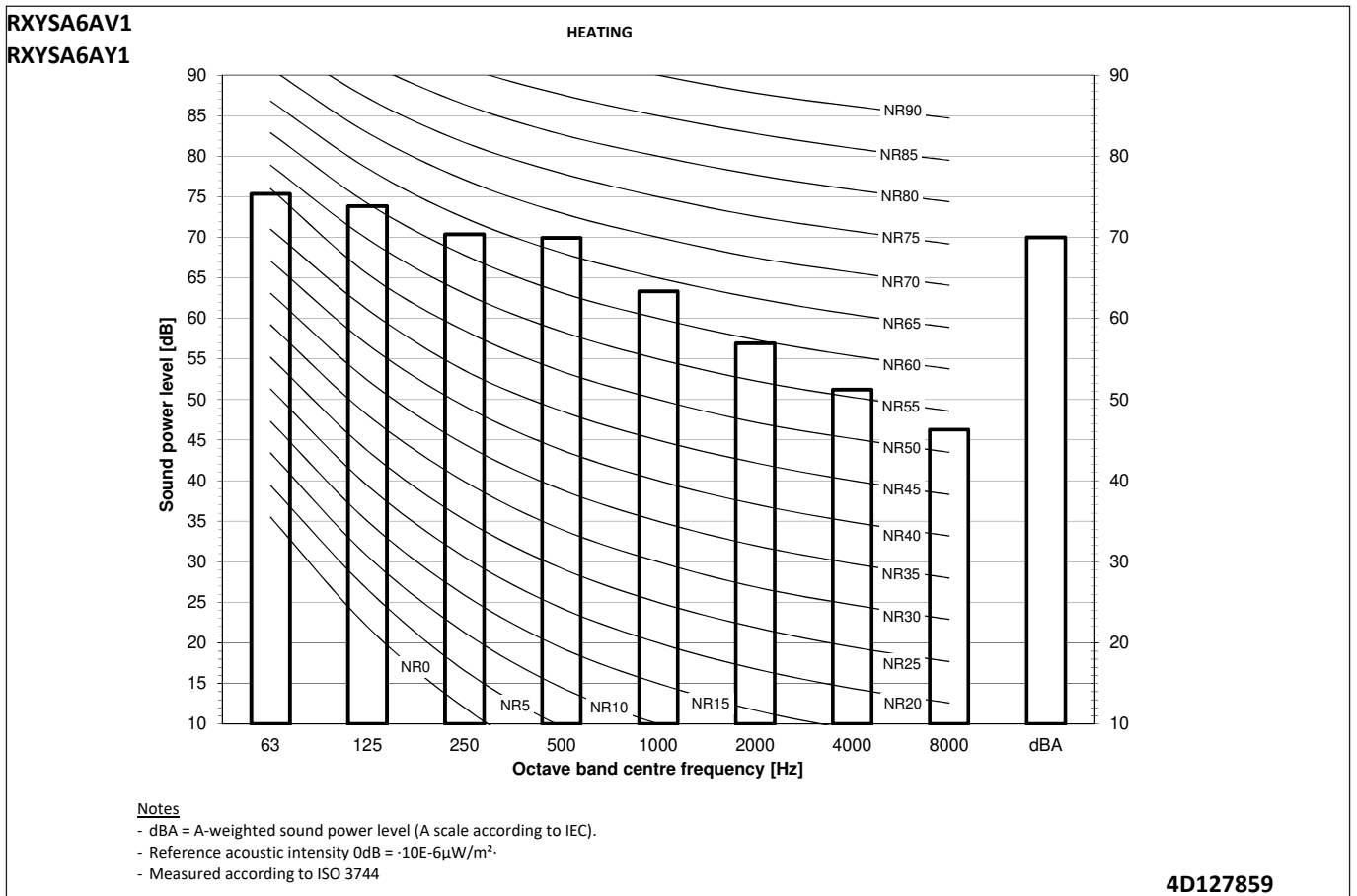
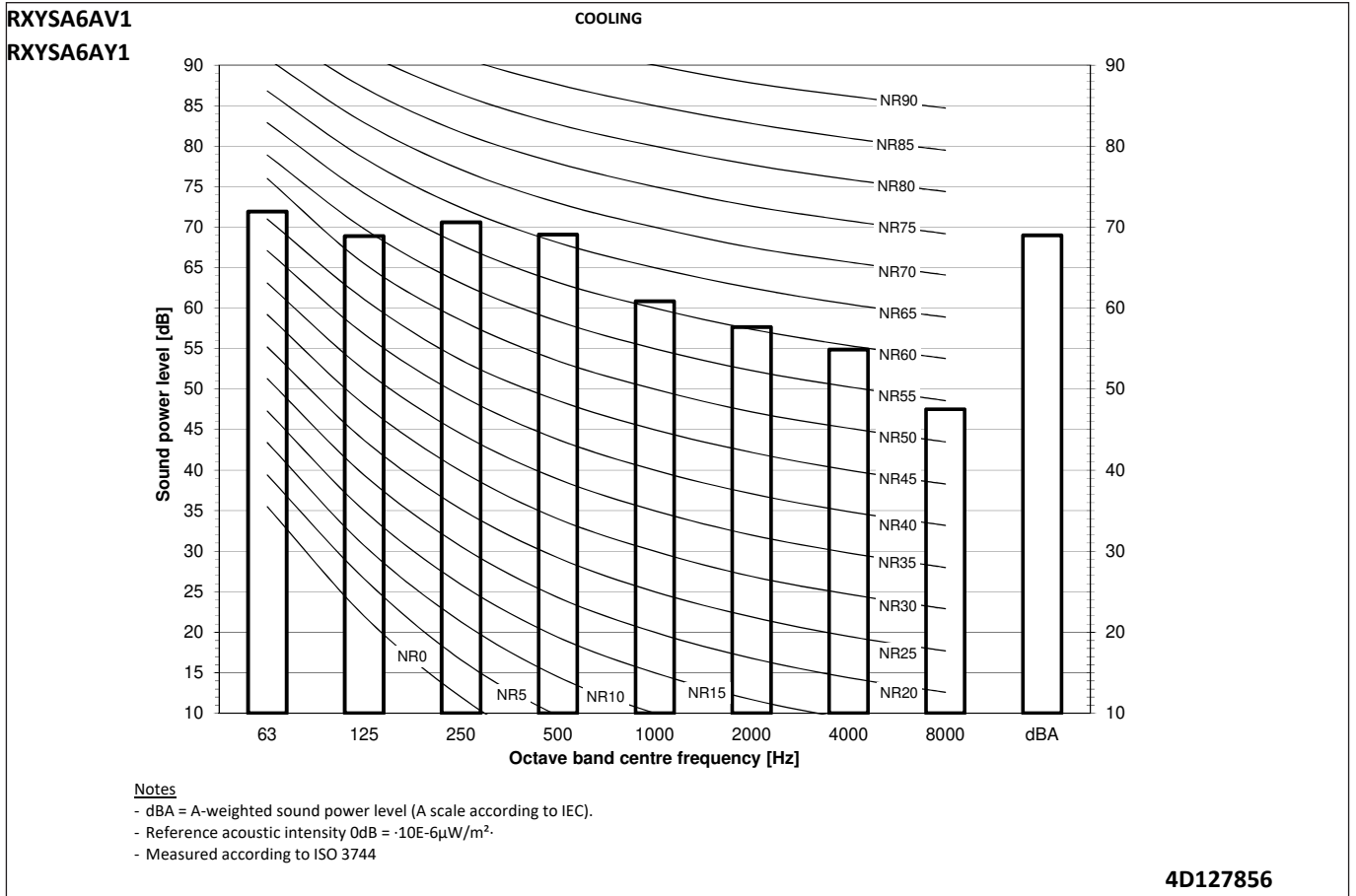

# 11 Sound data

## 11 - 2 Sound Pressure Spectrum - Cooling

11

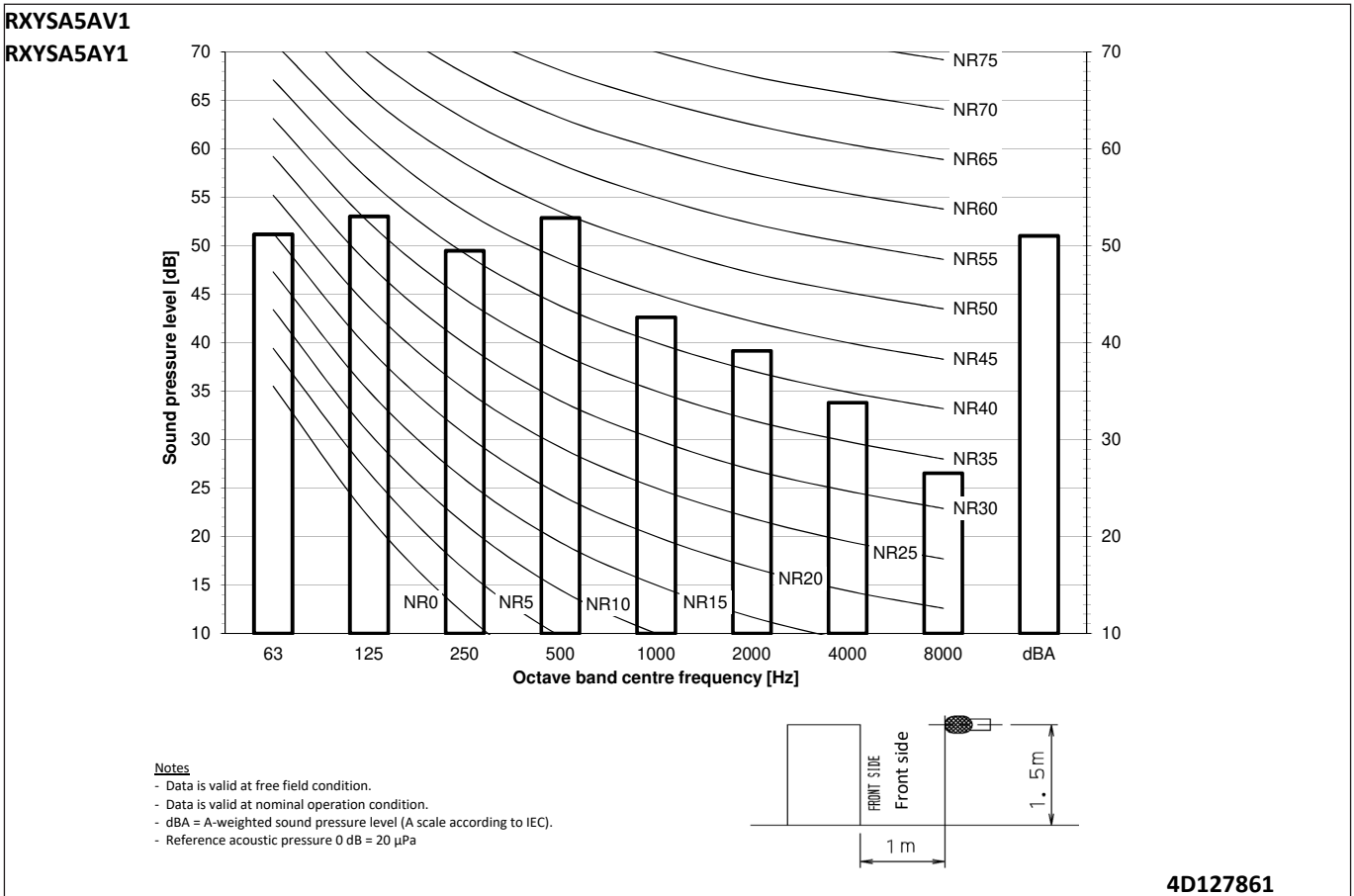
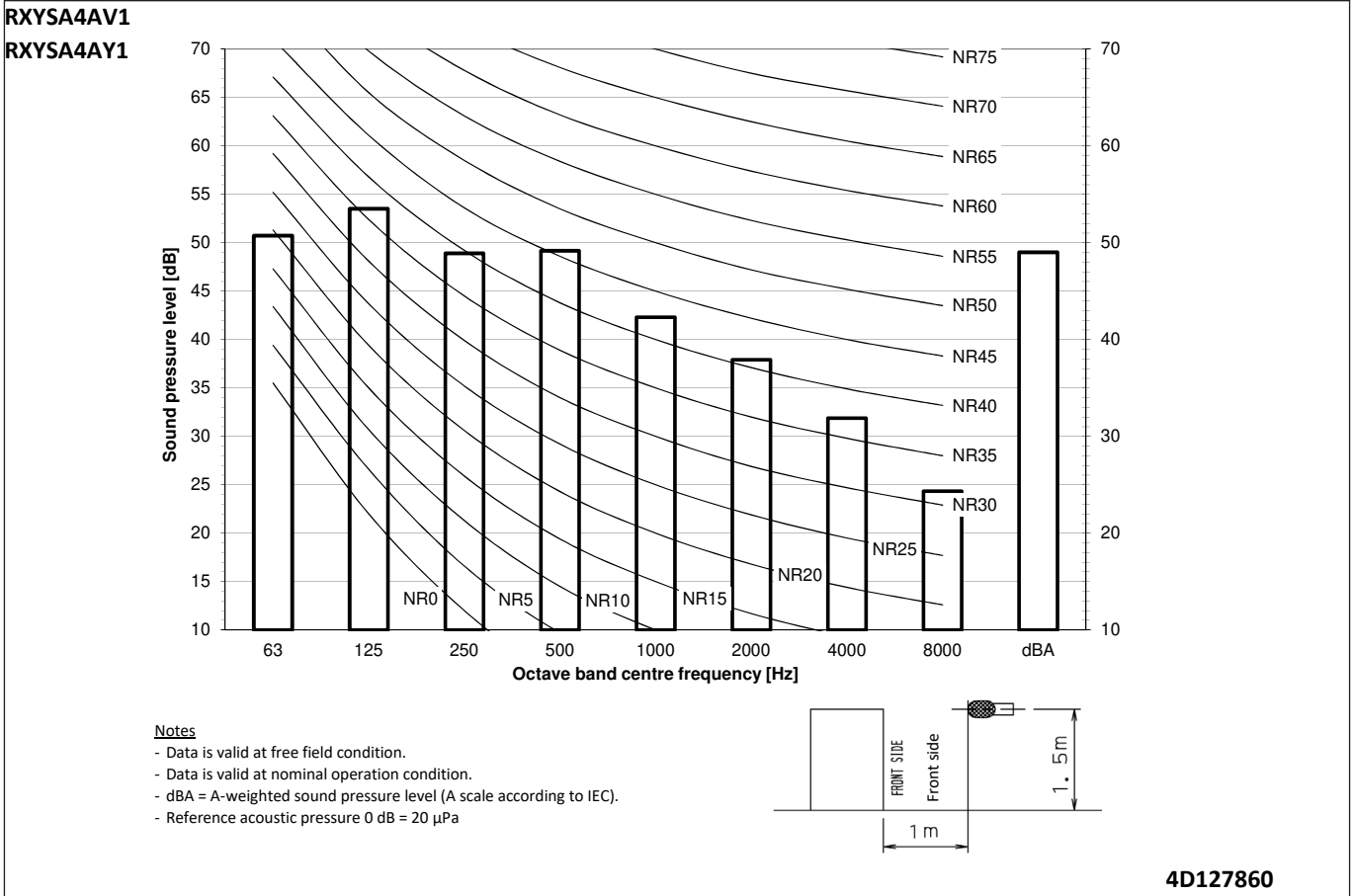

# 11 Sound data

## 11 - 2 Sound Pressure Spectrum - Cooling

RXYSA6AV1  
RXYSA6AY1

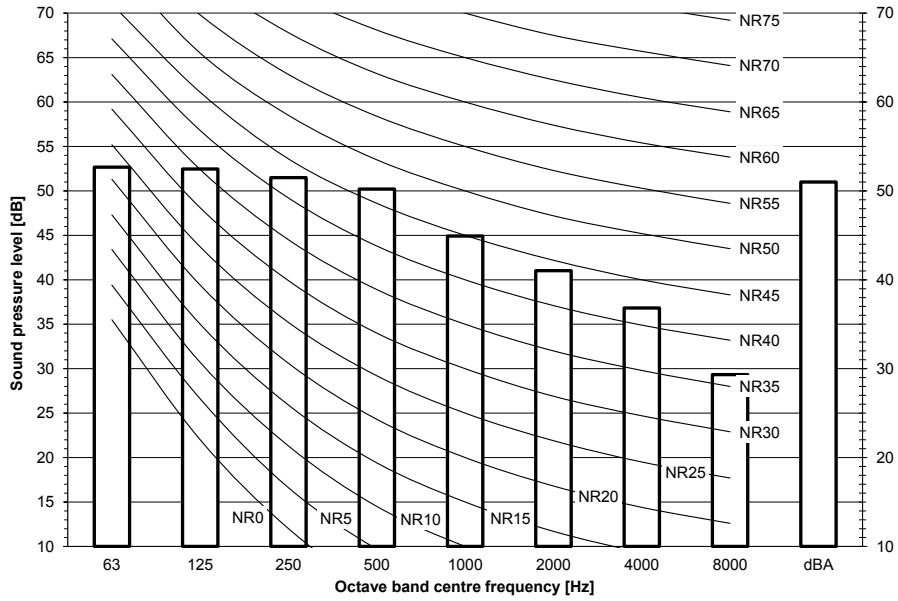

**Notes**

- Data is valid at free field condition.
- Data is valid at nominal operation condition.
- dBA = A-weighted sound pressure level (A scale according to IEC).
- Reference acoustic pressure 0 dB = 20 μPa

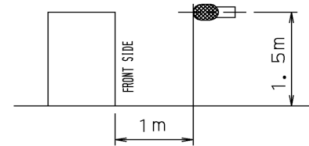

4D127862

# 11 Sound data

## 11 - 3 Sound Pressure Spectrum - Heating

11

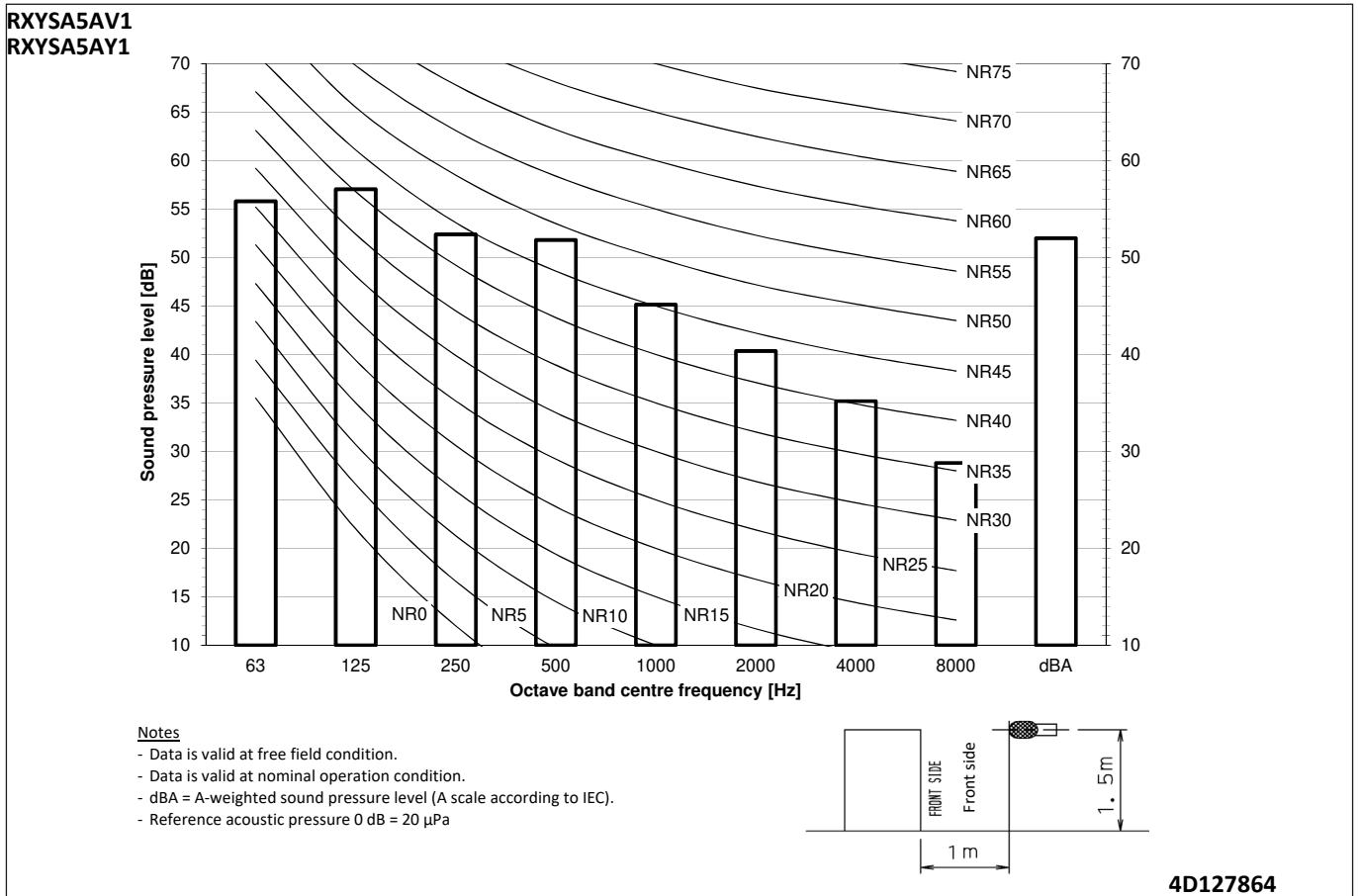
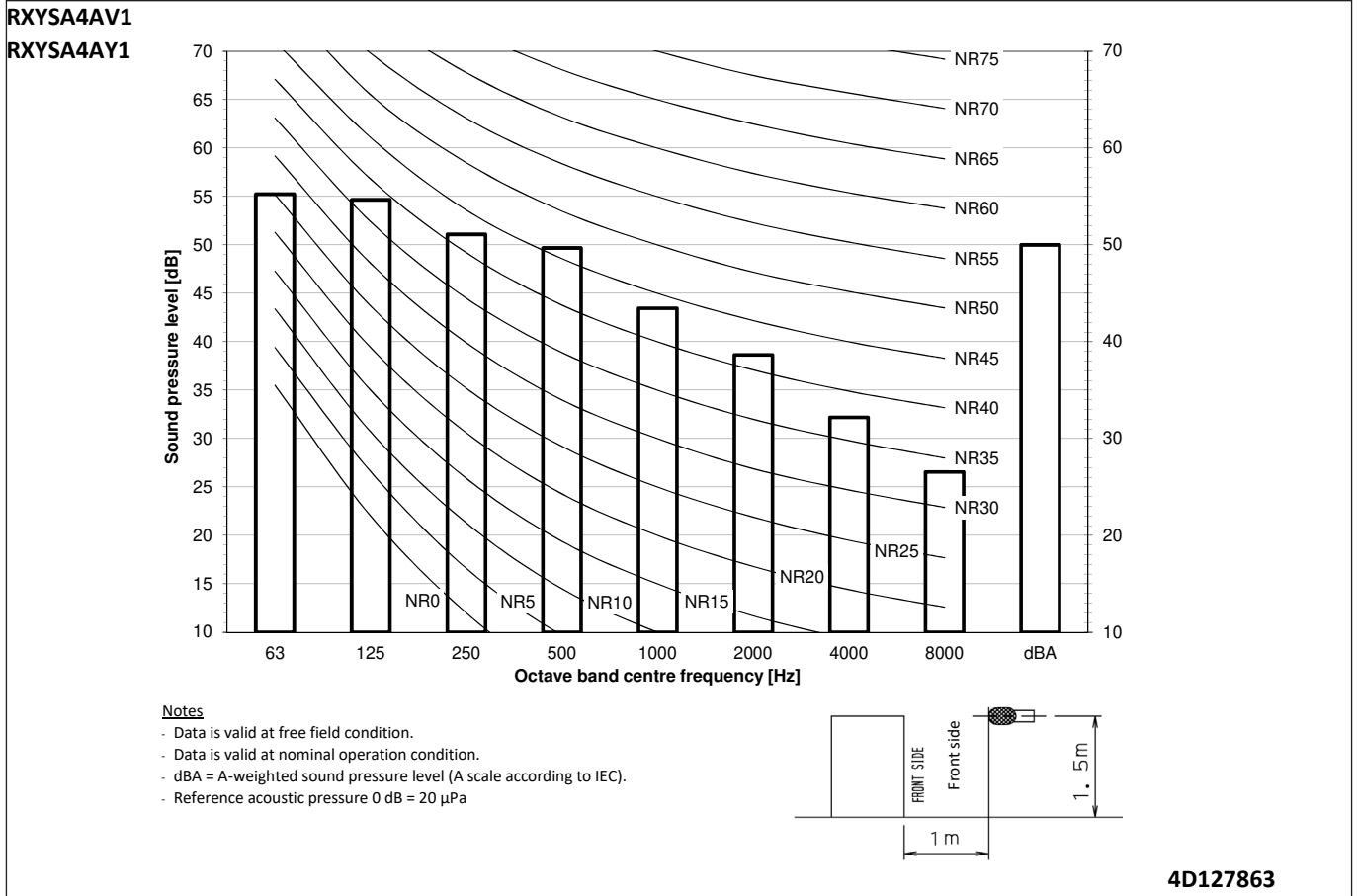



# 11 Sound data

## 11 - 3 Sound Pressure Spectrum - Heating

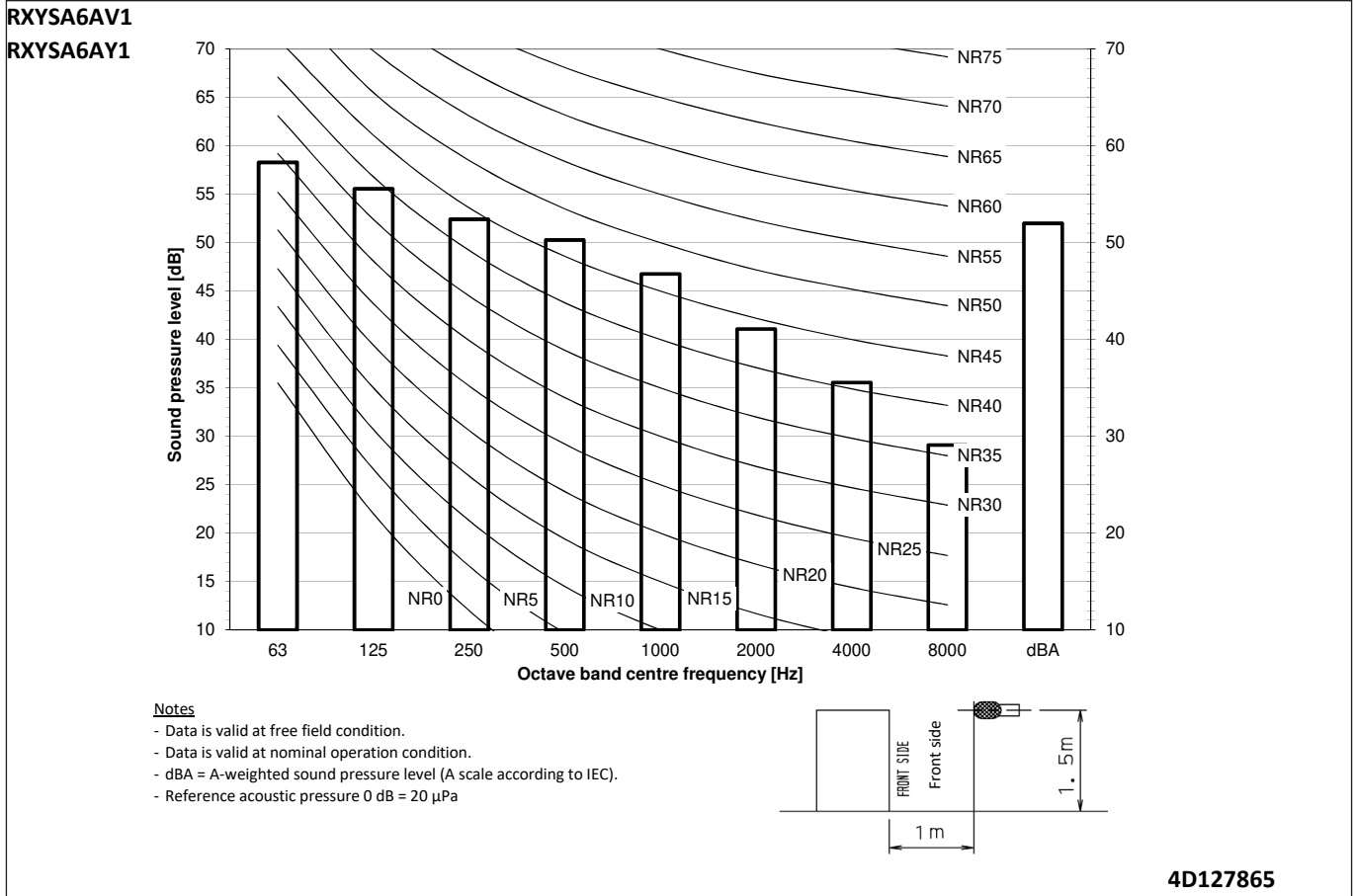

# 11 Sound data

## 11 - 4 Sound power spectrum at high ESP

11

RXYSA-AV1  
RXYSA-AY1

### VRV5-S Heat pump High ESP

4HP	Cooling	Heating
	Sound power [dBA]	Sound power [dBA]
ESP1	70	72
ESP2	75	77

6HP	Cooling	Heating
	Sound power [dBA]	Sound power [dBA]
ESP1	71	78
ESP2	75	78

5HP	Cooling	Heating
	Sound power [dBA]	Sound power [dBA]
ESP1	71	76
ESP2	75	77

Sound power is measured on a freestanding unit.  
Actual sound is depending on the installation of the duct.

4D127882

# 11 Sound data

## 11 - 5 Sound level data Quiet mode

**RXYSA-AV1**
**RXYSA-AV1**
**VRV5-S Heat pump**
**Low noise data (level ·1-5·)**

4HP	Cooling		Heating	
	Sound pressure [dBa]	Sound power [dBA]	Sound pressure [dBa]	Sound power [dBA]
LN1	47	65	48	66
LN2	45	64	46	64
LN3	43	62	44	62
LN4	41	59	42	60
LN5	39	57	40	58

5HP	Cooling		Heating	
	Sound pressure [dBa]	Sound power [dBA]	Sound pressure [dBa]	Sound power [dBA]
LN1	48	66	51	68
LN2	46	64	48	66
LN3	44	62	46	64
LN4	42	60	44	62
LN5	40	58	42	60

6HP	Cooling		Heating	
	Sound pressure [dBa]	Sound power [dBA]	Sound pressure [dBa]	Sound power [dBA]
LN1	49	67	51	69
LN2	47	65	49	67
LN3	45	63	47	65
LN4	43	61	45	63
LN5	41	59	43	61

	Capacity ratio
LN1	90%
LN2	75%
LN3	60%
LN4	45%
LN5	30%

LN1: Low noise level ·1·

LN2: Low noise level ·2·

LN3: Low noise level ·3·

LN4: Low noise level ·4·

LN5: Low noise level ·5·



**4D127868**

# 12 Installation

## 12 - 1 Installation Method

12

RXYSA-AV1  
RXYSA-AY1

Single unit (  ) | Single row of units (  )

### Suction side

In the illustration below, the service space at the suction side is based on 35°C DB and cooling operation. Foresee more space in the following cases:

- When the suction side temperature regularly exceeds this temperature.
- When the heat load of the outdoor units is expected to regularly exceed the maximum operating capacity.

### Discharge side

Take refrigerant piping work into account when positioning the units. If your layout does not match with any of the layouts below, contact your dealer.

Single unit (  ) | Single row of units (  )

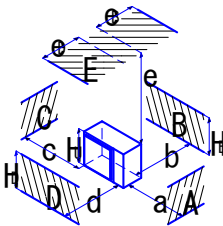
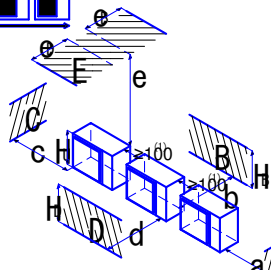
	A~E	Hb Hd Hu	(mm)								
			a	b	c	d	e	e <sub>B</sub>	e <sub>D</sub>		
	B	-		≥ 100							
	A,B,C	-	≥ 100 <sup>(1)</sup>	≥ 100	≥ 100						
	B,E	-	≥ 100				≥ 1000		≤ 500		
	A,B,C,E	-	≥ 150 <sup>(1)</sup>	≥ 150	≥ 150		≥ 1000		≤ 500		
	D	-				≥ 500					
	D,E	-				≥ 500	≥ 1000	≤ 500			
	B,D	Hd>Hu		≥ 100			≥ 500				
		Hd≤Hu		≥ 100			≥ 500				
	B,D,E	Hd>Hu	Hb≤½Hu	≥ 250			≥ 750	≥ 1000	≤ 500		
			½Hu>Hb≤Hu	≥ 250			≥ 1000	≥ 1000	≤ 500		
		Hb>Hu				⊘					
Hd≤Hu		Hd≤½Hu	≥ 100			≥ 1000	≥ 1000		≤ 500	1	
		½Hu<Hd≤Hu	≥ 200			≥ 1000	≥ 1000		≤ 500		
		Hd>Hu				⊘					
	A,B,C	-	≥ 200 <sup>(1)</sup>	≥ 300	≥ 1000						
	A,B,C,E	-	≥ 200 <sup>(1)</sup>	≥ 300	≥ 1000		≥ 1000		≤ 500		
	D	-				≥ 1000					
	D,E	-				≥ 1000	≥ 1000	≤ 500			
	B,D	Hd>Hu		≥ 300			≥ 1000				
		Hd≤Hu	Hd≤½Hu	≥ 250			≥ 1500				
			½Hu<Hd≤Hu	≥ 300			≥ 1500				
	B,D,E	Hd>Hu	Hb≤½Hu	≥ 300			≥ 1000	≥ 1000	≤ 500		
			½Hu<Hb≤Hu	≥ 300			≥ 1250	≥ 1000	≤ 500		
			Hb>Hu				⊘				
Hd≤Hu		Hd≤½Hu	≥ 250			≥ 1500	≥ 1000		≤ 500	1+2	
		½Hu<Hd≤Hu	≥ 300			≥ 1500	≥ 1000		≤ 500		
		Hd>Hu				⊘					

(1) For better serviceability, use a distance ≥ 250 mm

A,B,C,D Obstacles (walls/baffle plates)

E Obstacle (roof)

a,b,c,d,e Minimum service space between the unit and obstacles A, B, C, D and E

e<sub>B</sub> Maximum distance between the unit and the edge of obstacle E, in the direction of obstacle B

e<sub>D</sub> Maximum distance between the unit and the edge of obstacle E, in the direction of obstacle D

Hu Height of the unit

Hb,Hd Height of obstacles B and D

1 Seal the bottom of the installation frame to prevent discharged air from flowing back to the suction side through the bottom of the unit.

2 Maximum two units can be installed.

⊘ Not allowed

1D128513

# 12 Installation

## 12 - 1 Installation Method

RXYSA-AV1  
RXYSA-AY1

Multiple rows of units (  )

Multiple rows of units (  )

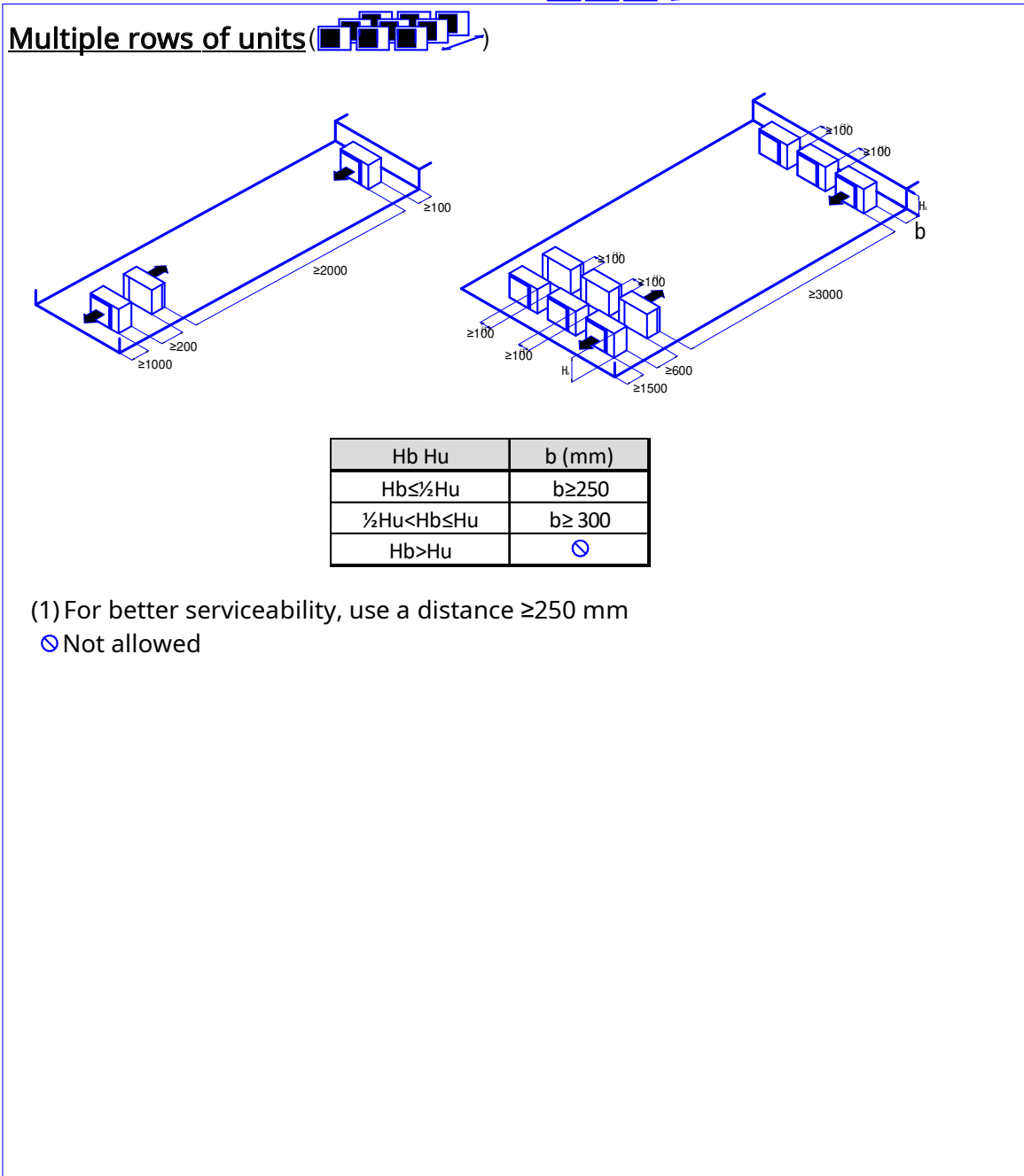

(1) For better serviceability, use a distance  $\geq 250$  mm

⊘ Not allowed

1D128513

# 12 Installation

## 12 - 1 Installation Method

12

**RXYSA-AV1**

**RXYSA-AY1**

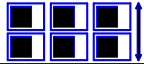
Stacked units (max. 2 levels) (  )

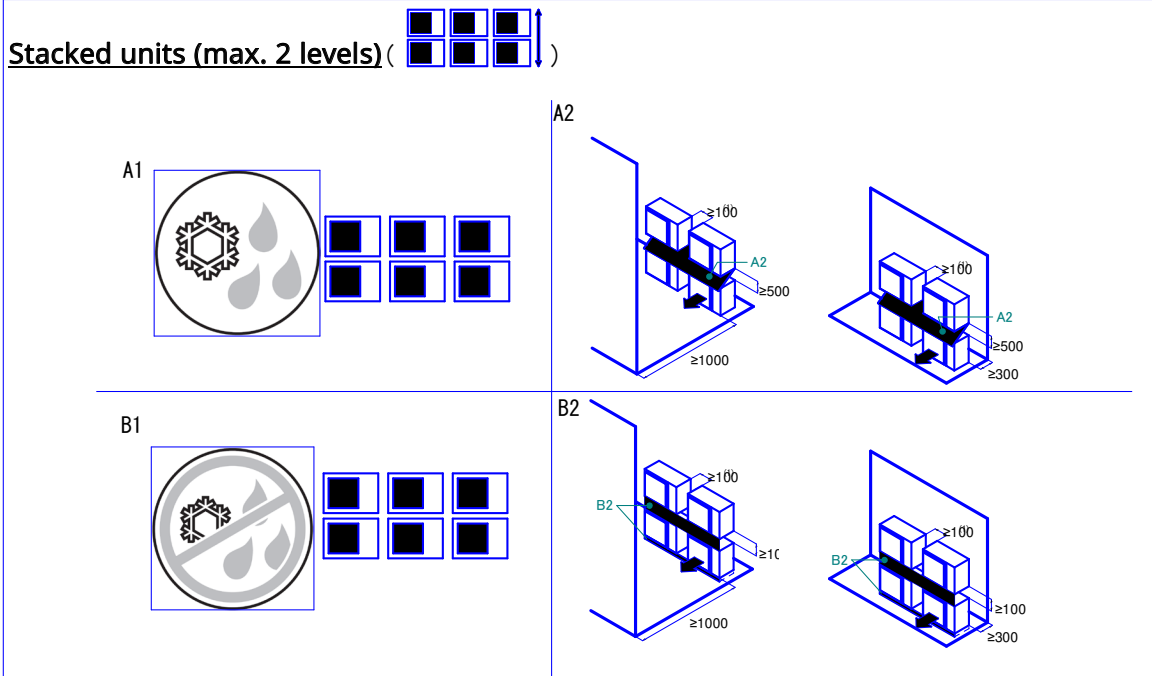

(1) For better serviceability, use a distance  $\geq 250$  mm

A1=>A2 (A1) If there is danger of drainage dripping and freezing between the upper and lower units...

(A2) Then install a roof between the upper and lower units. Install the upper unit high enough above the lower unit to prevent ice buildup at the upper unit's bottom plate.

B1=>B2 (B1) If there is no danger of drainage dripping and freezing between the upper and lower units...

(B2) Then it is not required to install a roof, but seal the gap between the upper and lower units to prevent discharged air from flowing back to the suction side through the bottom of the unit.

**1D128513**

# 12 Installation

## 12 - 2 Refrigerant Pipe Selection

RXYSA-AV1

RXYSA-AY1

### VRV5-S Heat pump Piping restrictions ·1/2·

		Maximum piping length		Maximum height difference		Total piping length
		Longest pipe (A+B) Actual / (Equivalent) See note ·1·	After first branch (B, C) Actual	Indoor-to-outdoor (H1) Outdoor above indoor / (indoor above outdoor)	Indoor-to-indoor (H2)	
VRV DX indoor unit	RXYSA4~6A7V1B RXYSA4~6A7Y1B	120/(150)m	40m	50/(40)m	15m	300m

**Notes**

1. Assume equivalent piping length of refnet joint = ·0.5· m and refnet header = ·1· m (for calculation purposes of equivalent piping length, not for refrigerant charge calculations).
2. Maximum total piping length also depends on refrigerant charge limitations. See ·4D128599·.

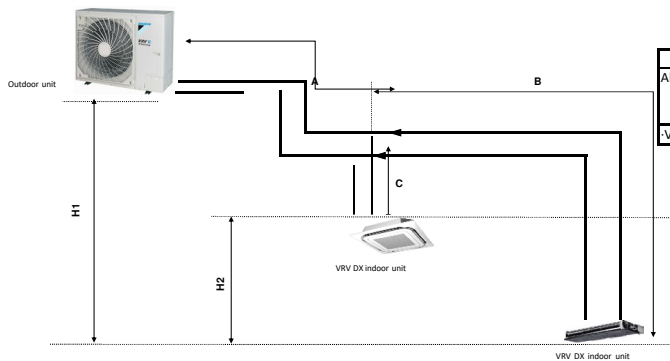

System pattern	Allowed capacity
Allowed connection ratio (CR)	VRV DX indoor unit
·VRV DX· indoor units only	50~130%

**Notes**

1. Schematic indication  
Illustrations may differ from the actual appearance of the unit.
2. This is only to illustrate piping length limitations.  
Refer to combination table ·3D127866· for details about the allowed combinations.

**4D127886**

RXYSA-AV1

RXYSA-AY1

### VRV5-S Heat pump Piping restrictions ·2/2·

System pattern	Allowed capacity
Allowed connection ratio (CR)	VRV DX indoor unit
·VRV DX· indoor units only	50~130%

**4D127886**

# 13 Operation range

## 13 - 1 Operation Range

13

### RXYSA-AV1

### RXYSA-AY1

**Notes**

- These figures assume the following operation conditions  
 Indoor and outdoor units  
 Equivalent piping length: 5m  
 Level difference: 0m
- Depending on operation and installation conditions, the indoor unit can change over to freeze-up operation (indoor de-icing).
- To reduce the freeze-up operation (indoor de-icing) frequency, it is recommended to install the outdoor unit in a location not exposed to wind.
- Operation range is valid in case direct expansion indoor units are used.  
 If other indoor units are used, refer to the documentation of the respective indoor units.
- If the unit is selected to operate at ambient temperatures <-5°C for 5 days or more, with relative humidity levels >95%, it is recommended to apply a Daikin range specifically designed for such application.  
 For more information, contact your dealer.

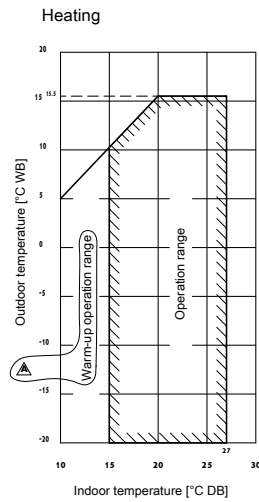
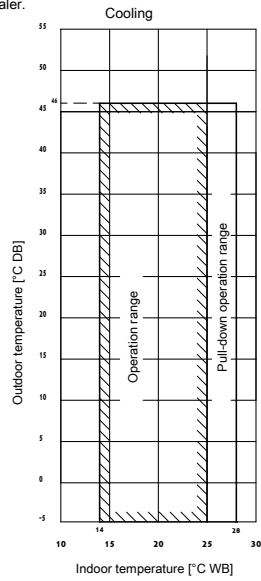

3D094664A



# 14 Appropriate Indoors

## 14 - 1 Appropriate Indoors

RXYSA-AV1

RXYSA-AY1

### Recommended indoor units for ·RXYSA\*A\*· outdoor units

· HP	4	5	6
	3xFXSA25 1xFXSA32	4xFXSA32	2xFXSA32 2xFXSA40

For details about the allowed combinations, see the engineering databook.

### Appropriate indoor units for ·RXYSA\*A\*· outdoor units

#### Covered by ·ENER LOT21·

- FXFA20-25-32-40-50-63-80-100-125
- FXZA15-20-25-32-40-50
- FXDA10-15-20-25-32-40-50-63
- FXSA15-20-25-32-40-50-63-80-100-125-140
- FXAA15-20-25-32-40-50-63

4D127887

---

**Daikin Europe N.V.** Naamloze Vennootschap · Zandvoordestraat 300 · 8400 Oostende · Belgium · [www.daikin.eu](http://www.daikin.eu) · BE 0412 120 336 · RPR Oostende (Responsible Editor)

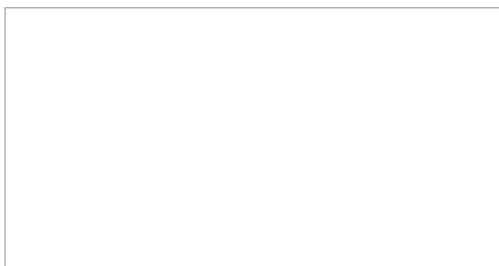

Daikin Europe N.V. participates in the Eurovent Certified Performance programme for Fan Coil Units and Variable Refrigerant Flow systems. Check ongoing validity of certificate: [www.eurovent-certification.com](http://www.eurovent-certification.com)

EEEN20

05/2020



The present leaflet is drawn up by way of information only and does not constitute an offer binding upon Daikin Europe N.V. Daikin Europe N.V. has compiled the content of this leaflet to the best of its knowledge. No express or implied warranty is given for the completeness, accuracy, reliability or fitness for particular purpose of its content and the products and services presented therein. Specifications are subject to change without prior notice. Daikin Europe N.V. explicitly rejects any liability for any direct or indirect damage, in the broadest sense, arising from or related to the use and/or interpretation of this leaflet. All content is copyrighted by Daikin Europe N.V.